

Automatic powder coating plant for pallet rack

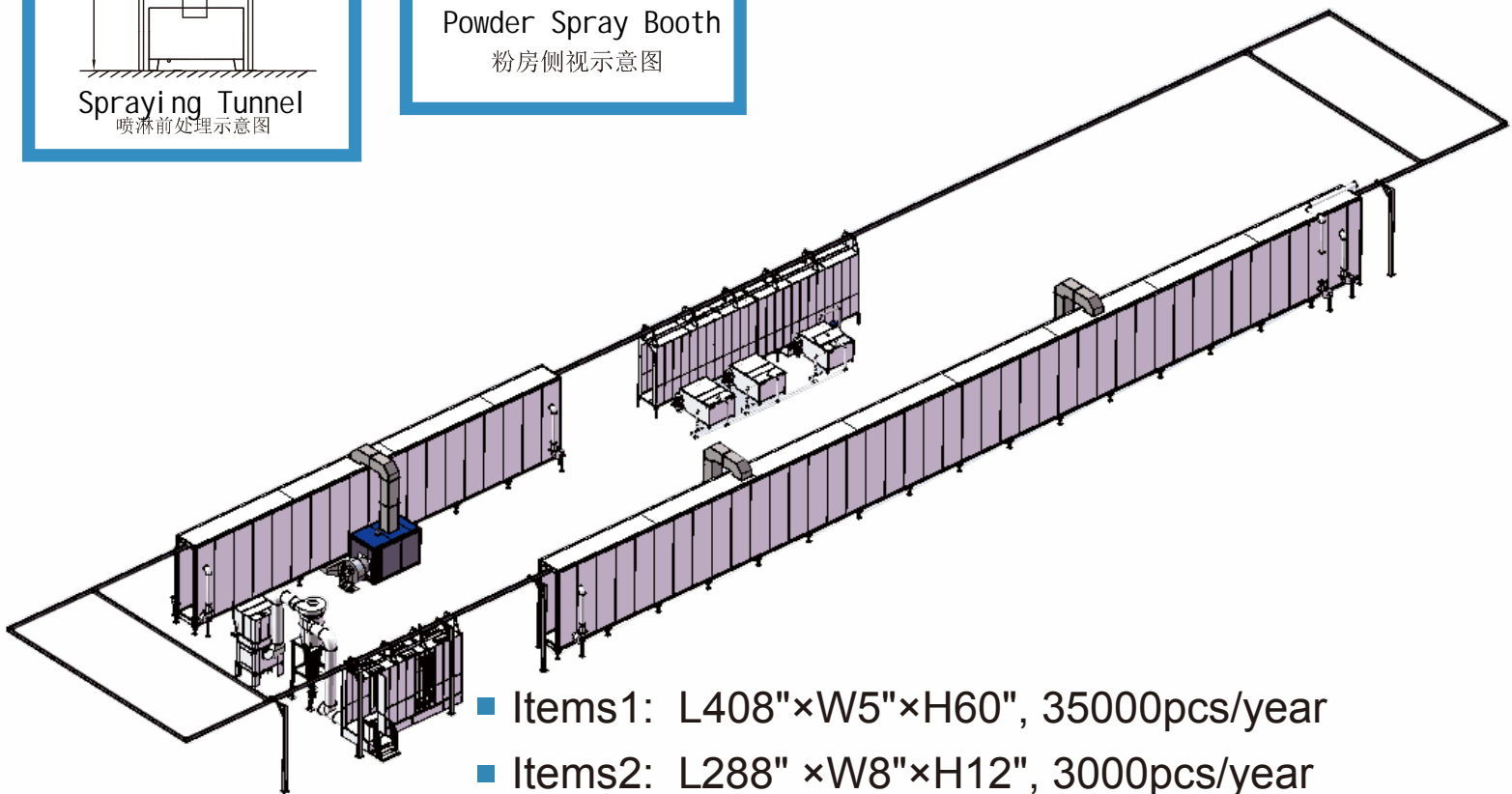

- Items1: L408"×W5"×H60", 35000pcs/year
- Items2: L288" ×W8"×H12", 3000pcs/year
- Workshop Area: 85000×36000×5400mm (L×W×H)

Customer provided photos

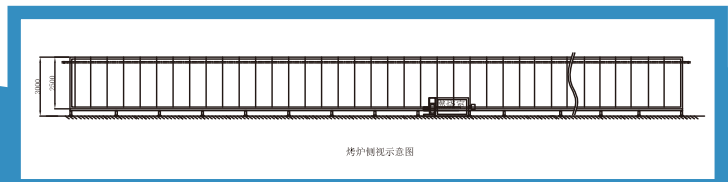
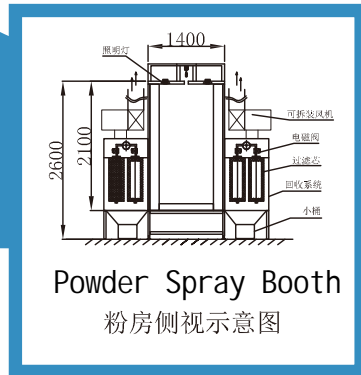
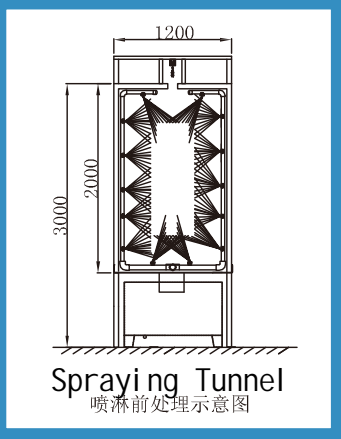
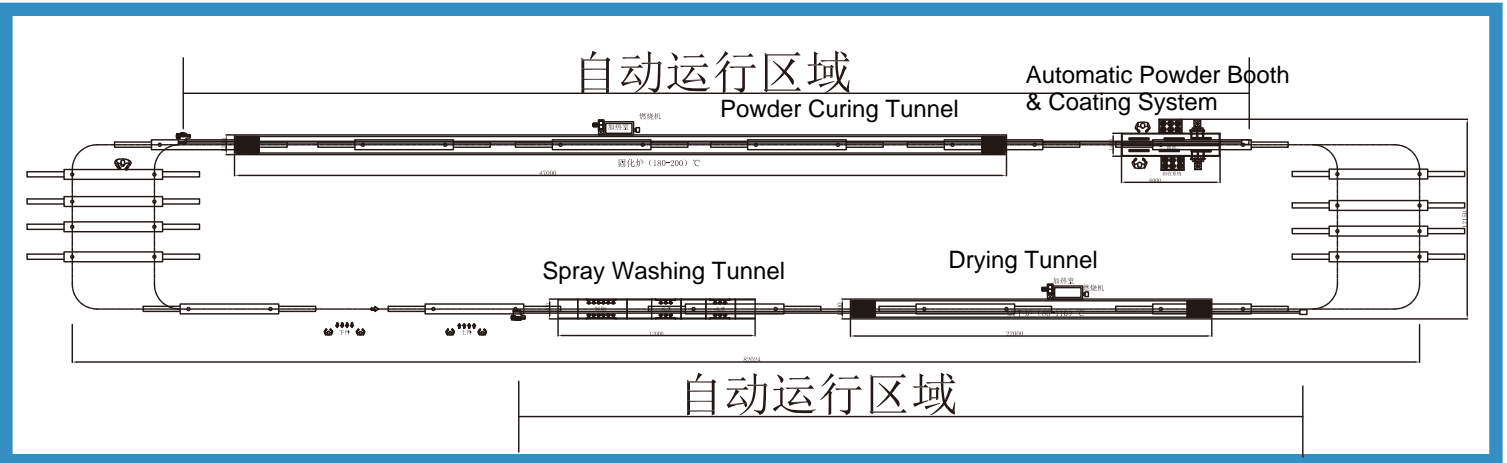
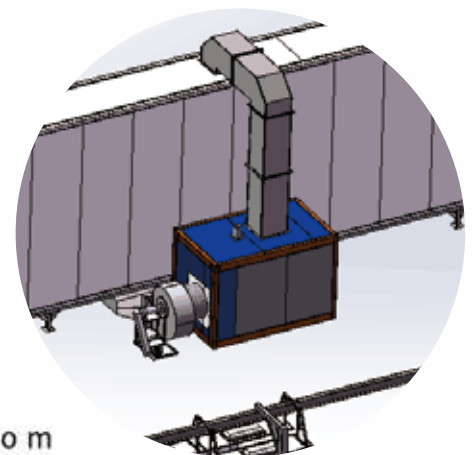
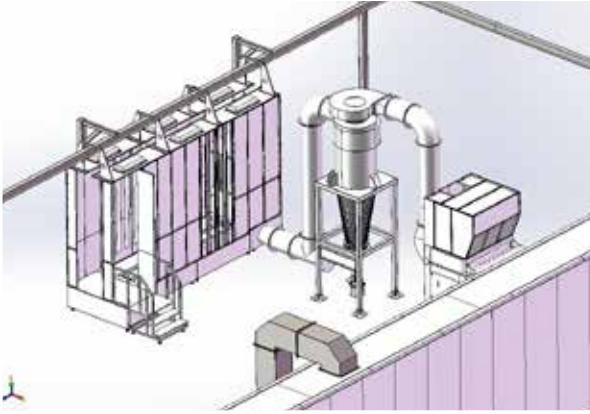

Application

